

cartonlab.

Módulo almacenaje  
Storage unit **OHM**

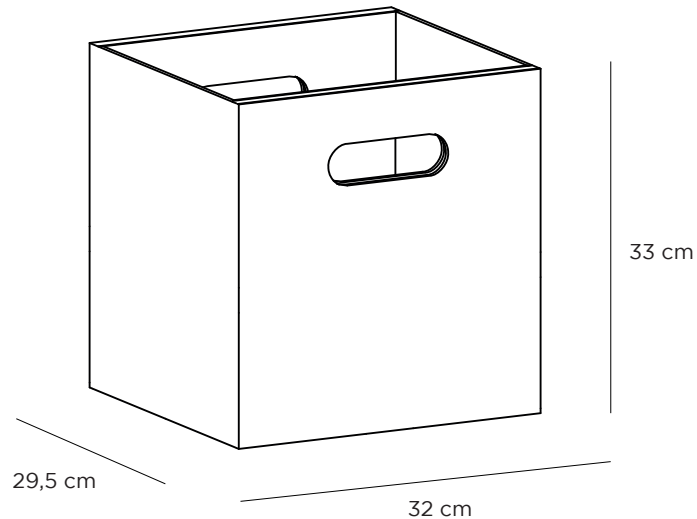



## MANUAL DE MONTAJE / ASSEMBLY GUIDE

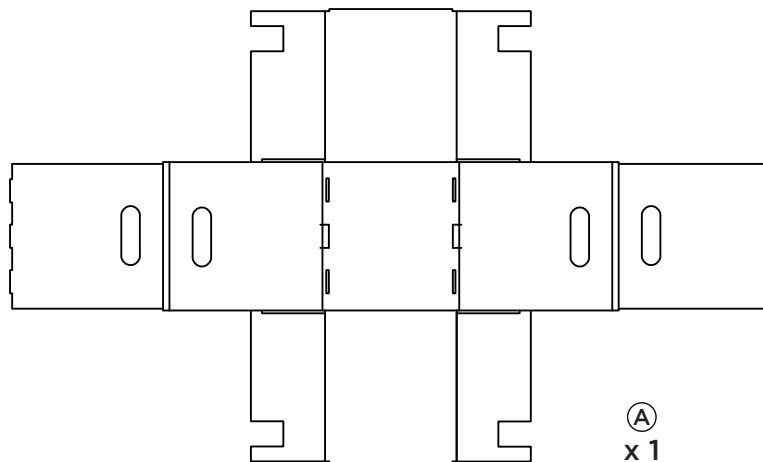

1 PIEZA / 1 PIECE



## CONSEJOS DE MONTAJE / ASSEMBLY TIPS

-  Tiempo de montaje: 3 minutos  
*Assembly time: 3 minutes*
-  No necesita pegamento.  
*No glue required*
-  Manipular con precaución, el cartón puede tener fillos de papel cortante. Sugerimos el uso de guantes.  
*Handle with care—the cardboard may have sharp paper edges. Gloves are recommended.*
-  Mantener alejado de la humedad y de fuentes incandescentes.  
*Keep away from moisture and heat sources.*
-  Fabricado con material certificado FSC. Producto 100% reciclable.  
*Made with FSC-certified material. 100% recyclable product.*

1

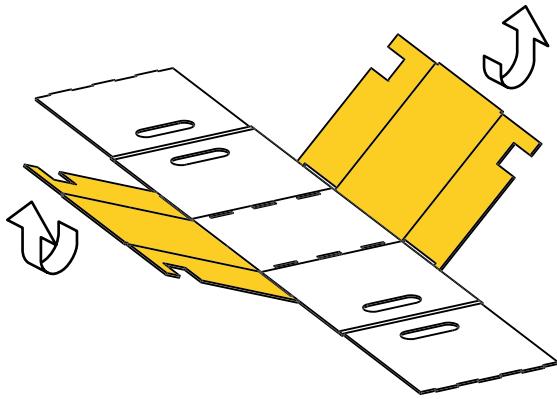

2

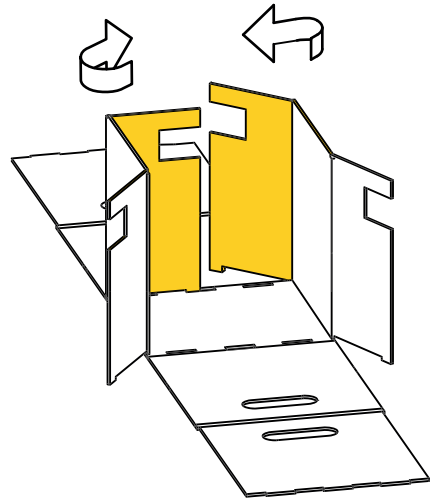

3

!! Encajar los dientes en los huecos de la base

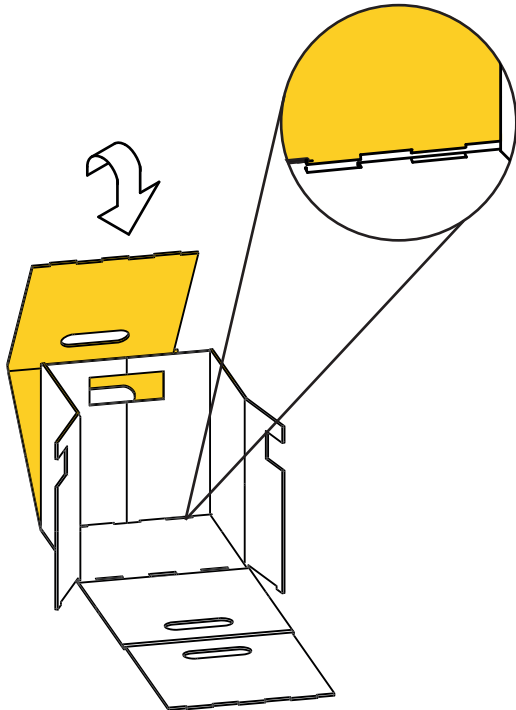

4

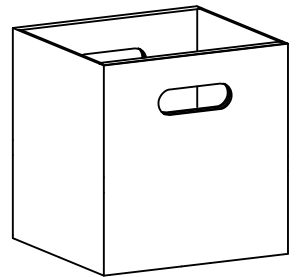

!! Repetir paso 2 y 3 en el otro lado

